

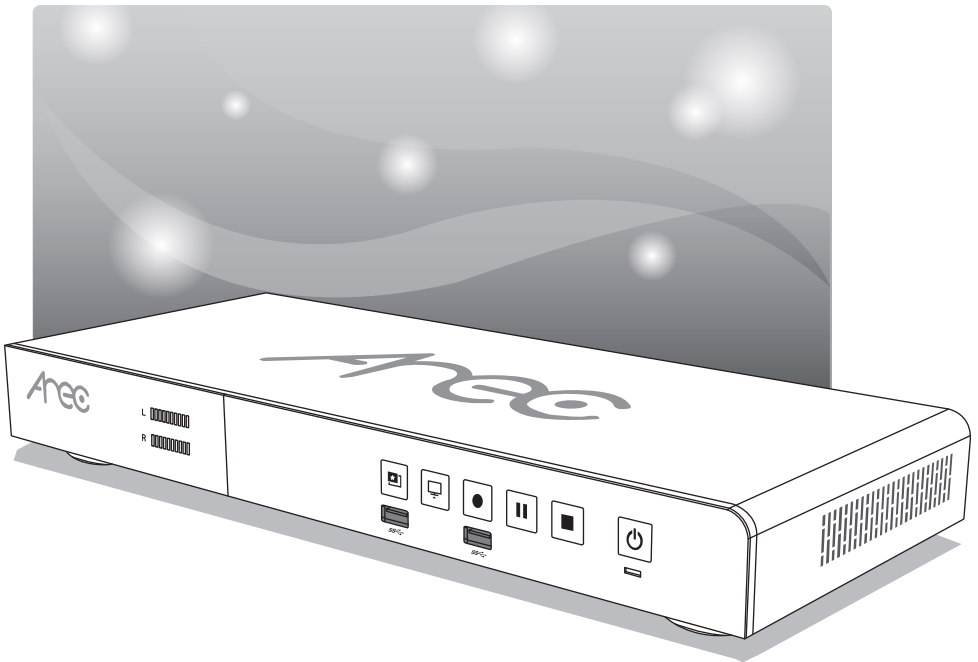

LS-410 Media Station

Quick Installation Guide | ENGLISH





FCC

Federal Communication Commission interference statement

This equipment has been tested and found to comply with the limits for a Class B digital device, pursuant to part 15 of the FCC rules. These limits are designed to provide reasonable protection against harmful interference in a residential installation. This equipment generates, uses and can radiate radio frequency energy and, if not installed and used in accordance with the instructions, may cause harmful interference to radio communications. However, there is no guarantee that interference will not occur in a particular installation. If this equipment does cause harmful interference to radio or television reception, which can be determined by turning the equipment off and on, the user is encouraged to try to correct the interference by one or more of the following measures: -Reorient or relocate the receiving antenna. -Increase the separation between the equipment and receiver. -Connect the equipment into an outlet on a circuit different from that to which the receiver is connected. -Consult the dealer or an experienced radio/TV technician for help.

RF Exposure Warning

The equipment complies with RF exposure limits set forth for an uncontrolled environment. The antenna(s) used for this transmitter must not be co-located or operating in conjunction with any other antenna or transmitter.

You are cautioned that changes or modifications not expressly approved by the party responsible for compliance could void your authority to operate the equipment.

FCC Caution

This device complies with Part 15 of the FCC Rules. Operation is subject to the following two conditions:

- (1) this device may not cause harmful interference and
- (2) this device must accept any interference received, including interference that may cause undesired operation

This equipment should be installed and operated with a minimum distance of 20 centimeters between the radiator and your body.

Notice: Any changes or modifications not expressly approved by the party responsible for compliance could void your authority to operate the equipment.



CE

Hereby, AREC Inc., declares that this Media Station is in compliance with the essential requirements and other relevant provisions of Directive 2014/53/EU.

CB

CB

CAUTION

Danger of explosion if battery is incorrectly replaced.

Replace only with the same or equivalent type.

- the ventilation should not be impeded by covering the ventilation openings with items, such as newspapers, table-cloths, curtains, etc.:
- no naked flame sources, such as lighted candles, should be placed on the apparatus;
- attention should be drawn to the environmental aspects of battery disposal;
- the use of apparatus in tropical climates.

the instructions for use shall state that the apparatus shall not be exposed to dripping or splashing and that no objects filled with liquids, such as vases, shall be placed on the apparatus.

Introduction

Featuring a compact and stand-alone design, AREC LS-410 Media Station consists of diverse features and functionality, including multi-signals capturing, recording synchronously, codec, streaming online, live broadcasting, and web-based monitor page, providing complete presentation or lecture capture solution.

Specifications

Product Name	Media Station
Model Name	LS-410
Dimension	401mm(L) x 167mm(W) x 54mm(H)
Weight	2250g
Power Requirement	12V/3.34A
Power Consumption (Max.)	40W (Max.)
Operating Temperature / Humidity	0°C ~ 40°C / 90%
Maximum normal load description	Insert 2 IP CAM to LAN port and insert 2 video signals (HDMI). Using external USB flash to record the transcoded video/audio. And output the transcoded video/audio to HDMI and DP ports.

Package Contents

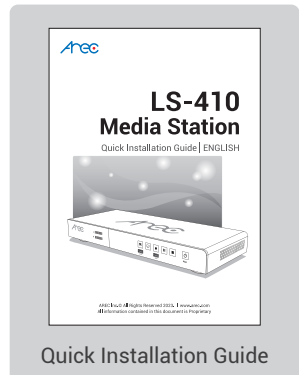
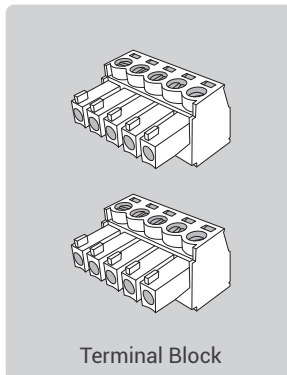
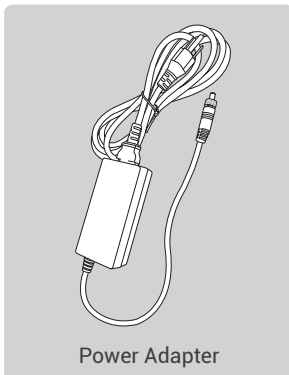
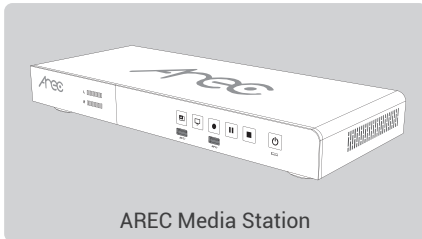

* Ear Mount. For mounting AREC Media Station in 19-inch 1U rack height.

Product Appearance

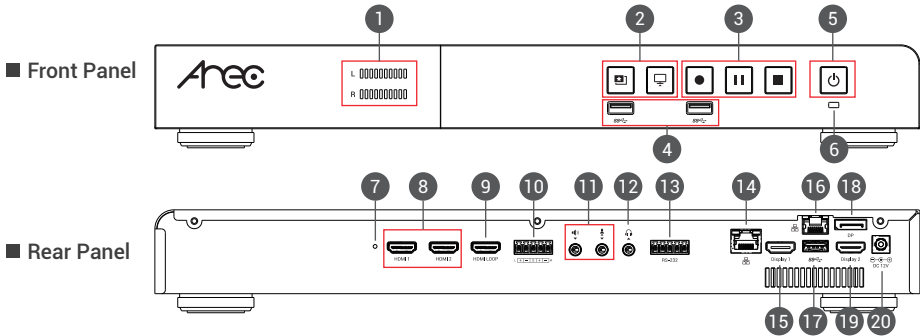

NO.	Name	Brief introduction
1	Audio meter	Audio volume bar
2	Layout function keys	Control the Layout functions
3	Record function keys	Control the Record, Pause, Stop functions
4	Front USB ports	1. For external USB storage device+ 2. Firmware update via USB disk 3. Available for USB mouse, keyboard 4. Available for USB video/audio input (Note: Connecting an USB AV device via an USB hub is not recommended. It may cause compatibility issues.) NOTE: Can detect and record to USB storage devices using FAT32, NTFS, Ext3, Ext4, exFAT file systems.
5	Power	Power on/off the device
6	Indicator	Red/Green dual color to show device status
7	Reset button	Long push to reset to default settings
8	HDMI inputs	HDMI input source for PC, Cameras
9	HDMI loop out	HDMI loop through from adjacent input port
10	Audio input	Balanced audio-in with a 5-pin Phoenix connector
11	Audio input	Line audio input / Mic audio input
12	Audio output	Line audio output
13	RS-232	Captive screw connector for control over RS-232
14	Ethernet port	RJ-45 Ethernet connector for WAN connection
15	Video output	HDMI output (preview recording with on-screen GUI)
16	Ethernet port	RJ-45 Ethernet connector for LAN connection
17	Back USB port	Function same as front ports
18	Video output	DisplayPort output (inputs monitoring or multi-source display)
19	Video output	HDMI output (inputs monitoring or multi-source display)
20	Power port	12V/ 3.34A

Connection

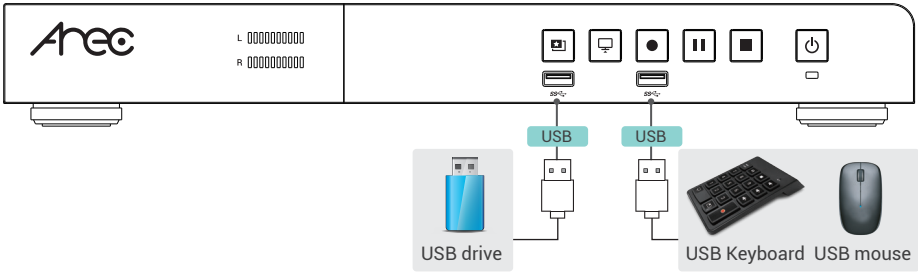
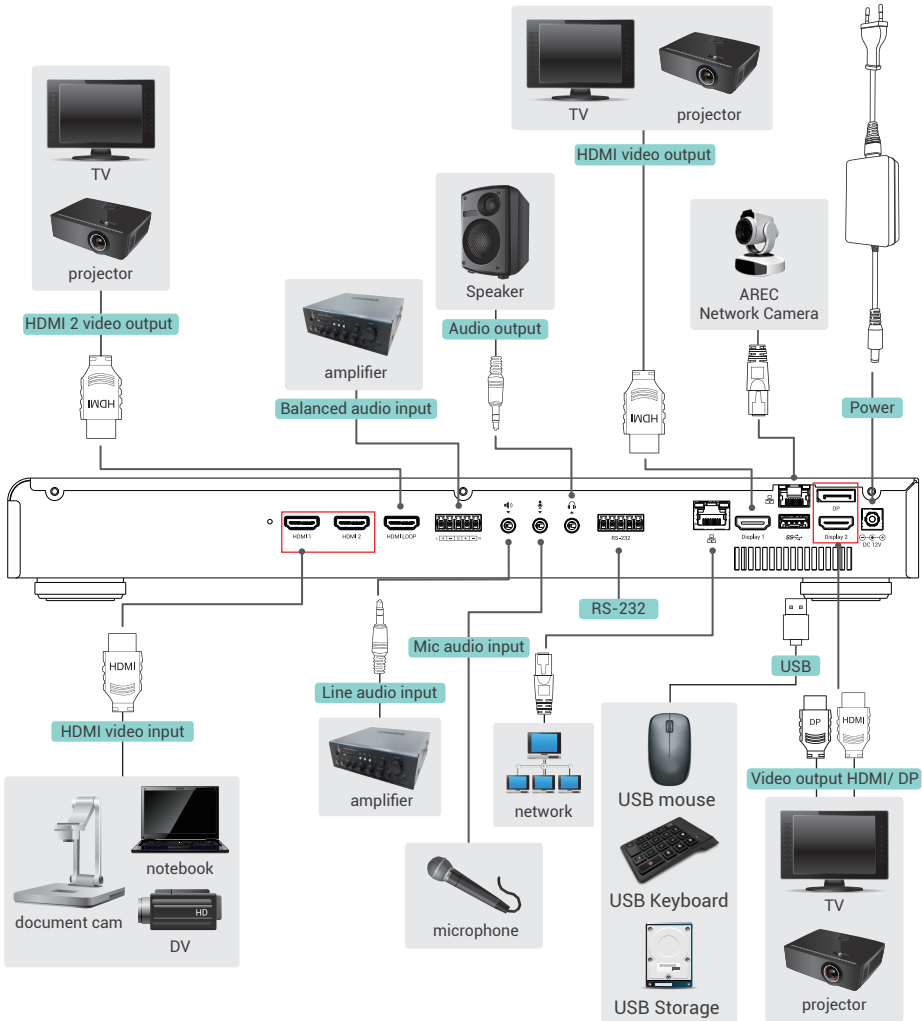

Accessing the Administrator pages

Connect PC to the setting port of Media Station with standard network cable. Open up the browser, and input 192.168.11.254 in the browser page. Log in Administrator  with default username admin and password admin, then entering System Administration webpages.

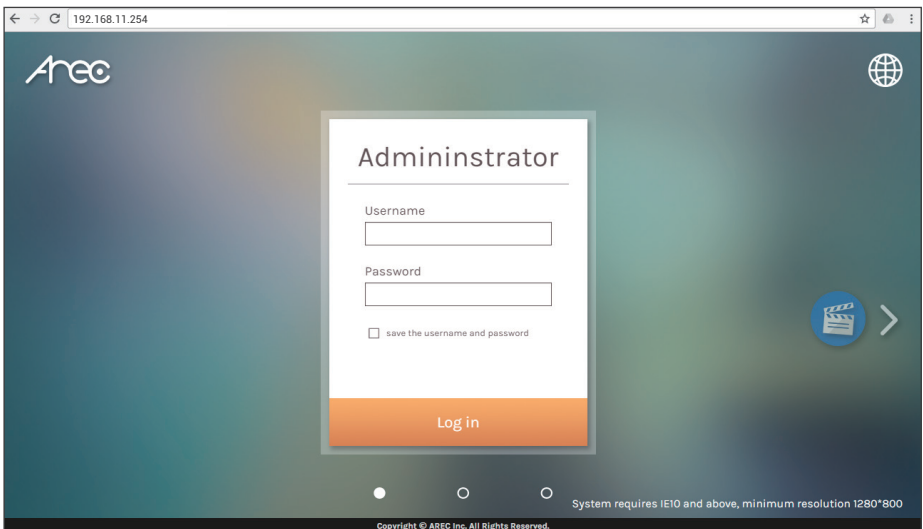
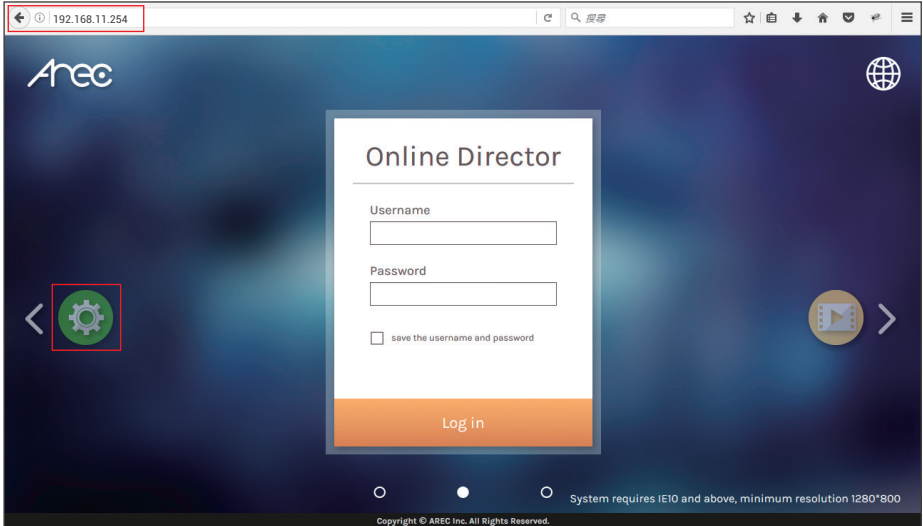

Setup

Step 1: Set up video input name, video source, PTZ control in [[Video inputs](#)] of [[Media I/O](#)]. The Capture source can be the video port [] and []. If only one of the latter is connected, the system would detect and automatically switch to source of signal. If both options are connected, set the capture priority between those.

If the desired video source is network camera, a login authentication with the camera is required firstly in the [[Network device manager](#)] setup tab of [[Media I/O](#)].

Host name	IP address	MAC	Brand	Status	Connected
AREC	10.2.50.118	00-00-89-0E-51-64	AREC	OK	OK
CI-T21H	10.2.50.144	E4-77-D4-01-18-B8	CI-T21H	OK	OK
CI-403	10.2.50.115	00-00-89-17-19-E3	CI-403	OK	OK

The system automatically scans and lists the network cameras connected to the Media Station once entering the [[Network device manager](#)] page. You may click Refresh button to scan again. Click Login button and the login authentication dialog pop out. Enter the username and password of the camera to complete the authentication and change the status to [**OK**]. Then the camera is ready for video input selection. Select the desired camera by its IP address. For video source of encoder, enter RTSP or RTP connection URL.

Step 2: Set up audio volume in [**Audio**] of [**Media I/O**].



Step 3: Set up date and time of host machine in [**System settings**] of [**System**].

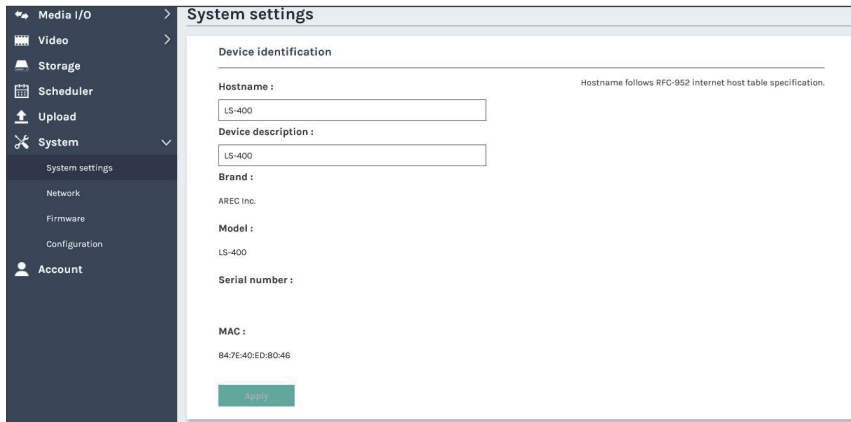

Getting start a recording

Start a recording from the front panel

Select the layout/ background before getting start. Press the front panel [] / [] button and select one layout/ background from the templates.

Press [] button and recording begins. The LED indicator of [] button is red to indicate active recording.

Press [] button to pause recording. The LED indicator of [] button flashes red while recording is paused. To resume recording, press [] button or press [] button. The preview and the output video are also suspended while recording is paused.

Press [] button to end a recording.

Start a recording via the Online director

Entering the Online director webpage via [System Administration] by clicking the [] button and opening a new tab; or log in Online director from the initial login page with default username director and password director. Both ways lead to the Online director control panel for web-based users.

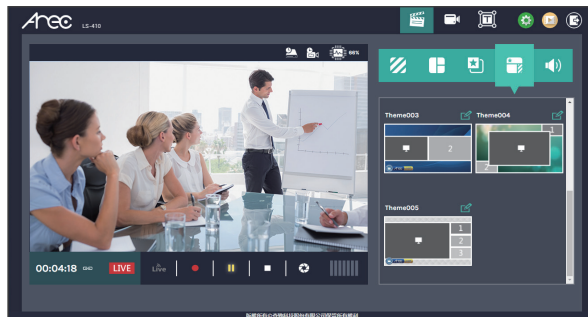
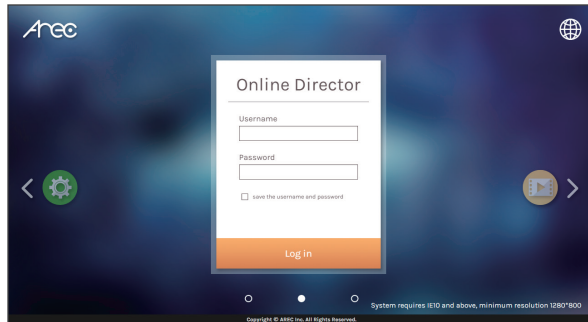
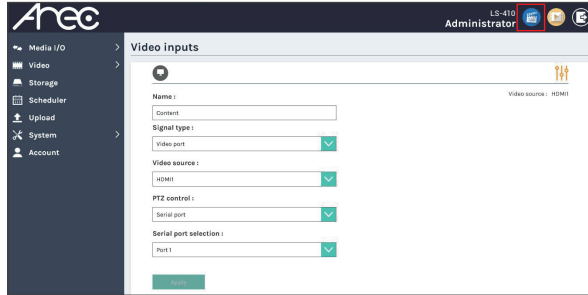

The Online director allows user to control recording and have a live stream view of the output video. The control panel makes it easy to apply layout, select background, and control the audio recorded during the recording process.

CAUTION
RISK OF EXPLOSION IF BATTERY IS REPLACED
BY AN INCORRECT TYPE.
DISPOSE OF USED BATTERIES ACCORDING
TO THE INSTRUCTIONS

Important Security Policy

■ Precautions

1. Please open the product package carefully; we commend you keep this packaging for future transport, storage or maintenance use.
2. There are no switches or adjustment buttons required for operation inside this product, so for your safety, please do not open the casing on your own, or vigorously rotate, shake or use any other inappropriate ways to operate this product in order to avoid electrical shocks and voiding the warranty. You can contact a local dealer directly if you have any questions.
3. Heat will be generated during the use of this product; therefore there must be sufficient ventilation for the temperature of the unit to remain at a stable status. So please use the product under normal environments to prolong the usage life, and avoid installing it in the following environments.
 - Locations that are unstable or have incomplete planes
 - Locations with powerful magnetic fields
 - Locations where it is damp or may have water leakage
 - Locations that are too hot, close to heaters and air hoses, or be exposed to direct sun light for long periods of time
 - Locations that are dusty
 - Locations where there are possible shocks
 - Locations close to power amplifiers
4. If you notice smoke or odor coming from the product, please quickly remove the power cable and send it to a maintenance center for processing.
5. To avoid electrical shock, the plug of the adapter should be stably and completely inserted into the power outlet and cannot be exposed; it must also have sufficient capacity to withstand the current transmission. Please do not plug the adapter into the power outlet before connecting the cable in order to avoid danger.
6. If not used for long periods of time, please unplug the power plug, and to ensure electrical safety, when unplugging the adapter, please hold the plastic part of the adapter with dry hands and then unplug the adapter. Please properly connect the cables according to the printed instructions on the installation manual and the machine to ensure optimized usage effects.



AREC Inc.© All Rights Reserved 2023. | www.arec.com
All information contained in this document is Proprietary



Made in Taiwan
Date : 2023.3.1
Version : 2.6